

## High Volume Storage Module (mHVS)

### Technical Data Sheet

The High Volume Storage Module (mHVS) stores high volumes of complete sample tubes from the Automation System in a temperature controlled and protected environment. It consists of an Input/Output Module (IOM), a Refrigerator Room with two doors, and a Waste Module. When stored, sample tubes can be retrieved based on a Host LIS, middleware, or user request. In this case, the racks containing the requested sample tubes are retrieved from the Refrigerated Room. After a predefined and a configurable time interval, the sample tubes are discarded into the Waste Module.

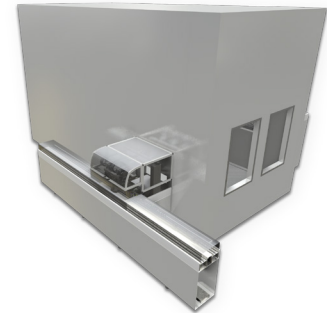

#### Benefits

- > Completely traceable sample storage under temperature-controlled conditions
- > Automatic storing and time configurable discarding of sample tubes
- > Modules of different sizes to match differing workload and space requirements

#### Applications

- > Storing of samples for possible rerun tests
- > Storing of samples for back-up and further analysis

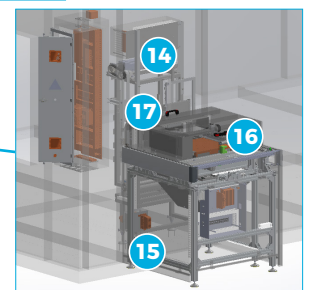
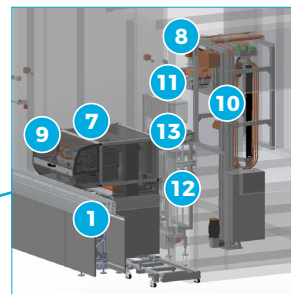
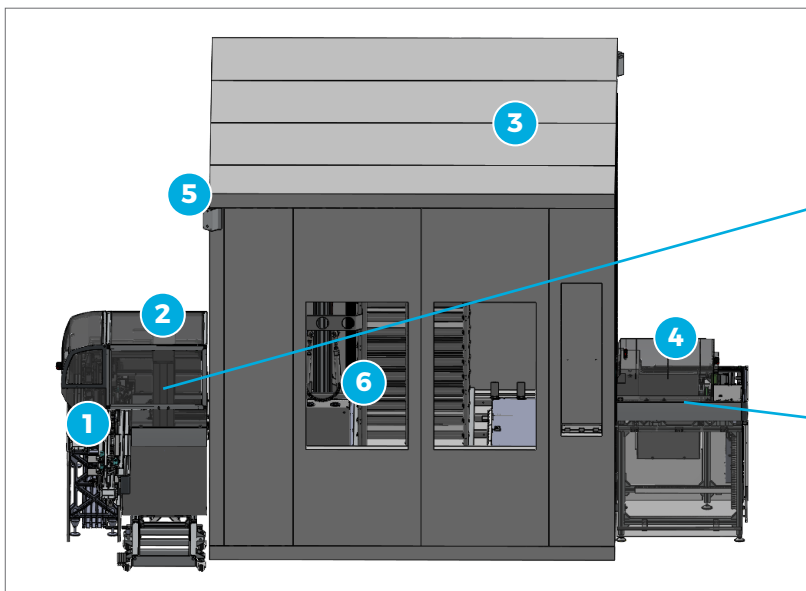

- |                                    |                          |                           |                          |                         |
|------------------------------------|--------------------------|---------------------------|--------------------------|-------------------------|
| <b>1</b> Buffer Lane               | <b>5</b> Lighting System | <b>9</b> Loading Robot    | <b>13</b> Buffer Shutter | <b>17</b> Waste Shutter |
| <b>2</b> Input/Output Module (IOM) | <b>6</b> Shelves         | <b>10</b> Traslo Elevator | <b>14</b> Waste Buffer   |                         |
| <b>3</b> Refrigerated Room         | <b>7</b> Unloading Robot | <b>11</b> Traslo Table    | <b>15</b> Waste Cabinet  |                         |
| <b>4</b> Waste Module              | <b>8</b> Retrieve Robot  | <b>12</b> Buffer Rack     | <b>16</b> Buffe Waste    |                         |

## Main Features

Throughput	Up to: 7200 tubes/h (input), 500 (retrieval), and 2800 (disposal) tubes/h*
Walk-away capacity	Depends on the type of bin capacity
Tube specifications	
Sample type	All tubes allowed on track
Cap type	Capped and Sealed
Dimensions (mm)	All tubes allowed on track
Position along the automation	In Post-analytical Area, after all analyzers and before Input area

\* Declared values are indicative of maximum performance obtained in optimized and standardized processing conditions, as tested by Inpeco. Historical field values should be used for system sizing and layout definition.

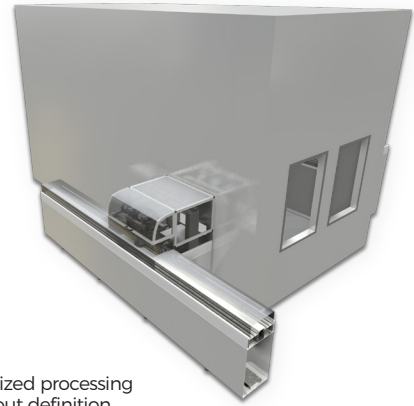

## Other Features

### mHVS overview

- > The mHVS IOM is equipped with a 400-position Rack Lanes and 40-position Rack Lanes to accommodate respectively 400-position and 40-position sample racks
- > The mHVS 400-position racks are used to store samples in the Refrigerated Room and 40-position racks to retrieve samples from the Refrigerated Room to the track
- > The mHVS Unloading Robot moves sample tubes from the track to 400-position racks in batch of 10 sample tubes or less (when no more tubes are expected within a configurable time interval)
- > The mHVS Traslo Elevator moves the 400-position rack into each shelf of the Refrigerator Room to be stored
- > The mHVS Retrieve Robot on the Traslo Elevator moves one sample tube at a time from 400-position racks to 40-position racks on the Traslo Table, prioritizing the STAT samples
- > The mHVS Loading Robot moves one tube at a time from 40-position racks to the track
- > The mHVS temperature and temperature warning thresholds settings are configurable out of the range of the controlled room temperature (from +2°C to +6°C)
- > The mHVS has a dedicated PC provided with its own software and database and a backup PC, to restore the configuration parameters
- > The mHVS displays the list of all 400-position racks and 40-position racks with the information about their ID, location in the Refrigerated room and status
- > The mHVS interfaces with a Database to store sample information about ID, location in rack, disposal time and status
- > The mHVS has a steady lighting system to highlight the different status conditions (error, warning, operational) and a blinking lighting system for online and offline status, online/offline transitions, and when at least one door is open
- > The mHVS Module monitors and displays the Refrigerated Room temperature

### Refrigerated Room

- > The Refrigerated Room has two corridors for the movement of the Traslo Elevator
- > The Refrigerated Room is equipped with a Buffer Shutter to separate the IOM from the Buffer Rack
- > The Refrigerated Room has two doors to access the cell during the inspection or maintenance

- > The Refrigerated Room can accommodate Evaporators that each customer has to choose by himself. See Appendix for available space inside the Refrigerator Room.

### Buffer Rack Module

- > The Buffer Rack Module allows the temporary allocation of sample racks
- > The Buffer Rack Module has an Elevation System to vertically move the shelves
- > The Elevation System has four shelves with two lanes each, one for the 400-position rack and one for 40-position rack
- > The Buffer Rack Module allows each shelf to be automatically moved at the same level as the IOM Table for the loading/unloading rack

### Waste Module

- > The mHVS disposes sample tubes, emptying each 400-position rack according to the highest disposal time among all tubes inside the rack
- > The Waste Buffer Rack Module allows the temporary allocation of 400-position racks in the four shelves (one per shelf)
- > The Waste Buffer Rack Module has an Elevation System to vertically move the four shelves to reach the same level as the Waste Table for the loading/unloading process
- > The Waste Standard Bin is the basic configuration from which a modular extension can be generated, based on the bin chosen by the customer.

### BackUp

- > Each mHVS supply must include one Traslo Tool and one IOM Tool per system
- > The Traslo Tool includes one Traslo Elevator Backup Module, functionally and structurally identical to the primary Traslo Elevator to be used when necessary
- > The IOM Tool consists in one IOM tester, designed to facilitate the service maintenance on the IOM unit of the mHVS and an IOM Backup Module that can support up to two mHVS modules

Technical Specifications	96k mHVS	153k mHVS	240k mHVS	336k mHVS
Dimensions (LxHxD) (mm)	4430x2620x3170	5630x2620x3170	6630x2980x3170	6630x3170x3700
Main clearances (left x right x front) (mm)	1050x2580x1500, minimum additional service clearances of 380 mm from mHVS maximum height to the ceiling			
Minimum tot lab height required (mm)	3000	3000	3360	4080* this height must be guaranteed along the complete path to move the Backup Traslo from its initial position to the mHVS Refrigerated Room Entrance
Corridors	2	2	2	2
Shelves (rows)	12	12	15	21
Columns	5	8	10	10
Tot 400-positions rack available	240	384	600	840
Weight (Kg)	4616	6614	9340	14025
Compressed air requirements				
Compressed air (NL/min)	16.05			
particle:humidity:total oil (ISO 8573-1:2010)	Class 3:4:3			
Pressure	0.7 MPa			
Tubes Diameter - for inlet - for water drain condensation	16 mm 10 mm			
Power Inlet Point	400Vac (3 Phases and 1 neutral)			
Maximum continuous current (A)	/			
Maximum alternate current (A)	10			
Total power consumption (VA)	7500VA			
Heat (BTU/h)	10880.0			
Noise (dBA)	less than 70 dB, measured at 1m distance and refrigerator offline			
Distributed load on floor (kg/m2)	580			
Floor requirements	The floor around and in correspondence of the mHVS should be flatten as much as possible, avoiding steps to allow the Backup Traslo and IOM movement inside the lab.			
Flatness	F ≤ 2 mm along 1 meter between subsequent floor peaks (both for raised floor and reinforced concrete)			
Levelness	L ≤ 10 mm along 6 meters (both for raised floor and reinforced concrete)			
Irregularities	no steps in the floor are present in the area around the refrigerated room (minimum 1 m per each side) and along the paths where the Backup Traslo and IOM could be moved when necessary			

\*Each height to be confirmed according to the evaporators position and evaporators height. See the dedicated Appendix Section below.

Ordinary Maintenance		Part Numbers	FlexLab™	FlexLab™ for High Throughput
Operator <sup>1</sup>	Depending on disposal time and waste bin capacity	Modules		
		mHVS 96K	N.A.	FLX-281-11
		mHVS 153K	N.A.	FLX-280-11
Service <sup>2</sup>	Every 30-180 days, according to operations	mHVS 240K	N.A.	FLX-272-11
		mHVS 336K	N.A.	FLX-279-11
		Slot	N.A.	FLX-583-11
		Traslo Cage Tool	N.A.	0A00026190
		Traslo Backup	N.A.	0A00027259
		IOM Tester Tool	N.A.	0A00026189
		IOM Backup	N.A.	0A00028210

<sup>1</sup> According to Operation Manual. <sup>2</sup>The periodicity depends also on the routine tubes/day. For more details refer to Service Manual.

N.A. = Not Available.

## Technical Drawing

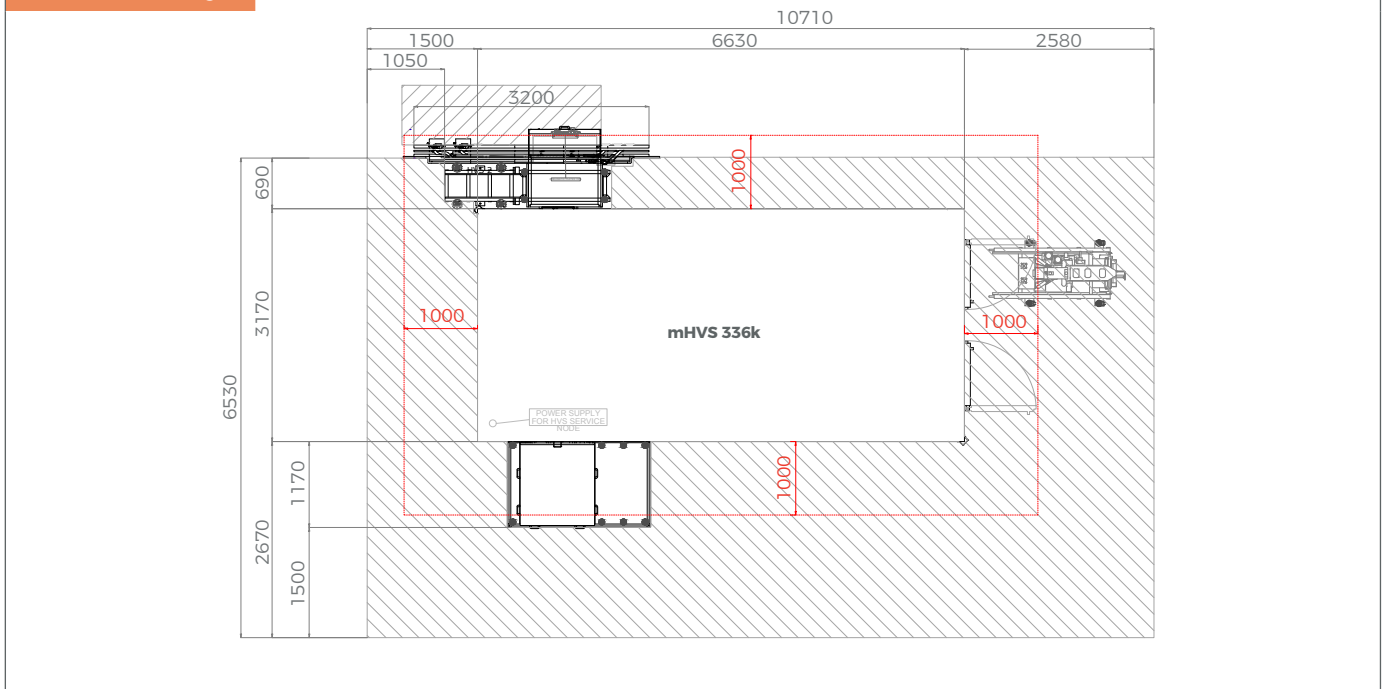

Module dimensions and clearances expressed in mm.

## Appendix

In this section the technical specifications of each mHVS main components are reported.

Refrigerated Room Requirements	336k mHVS
External dimensions (mm)	
Length	6630
Width	3170
Height	3700
Internal dimensions (mm)	
Length	6430
Width	2970
Height	3500
Traslo max height	3388
Internal net volume (m <sup>3</sup> )	70.66
Isolation panels thickness (mm)	100
Isolation floor thickness (mm)	100
Isolation material	Polyurethane high density
Isolation panel thermal conductivity coefficient (W/mm <sup>2</sup> °K)	0.021
Internal thermal load	1 KW robotics
	N°2 input/output cuts 500 x 200 mm <sup>2</sup> /each (open only during rack input/output transit, 36 times/h, 10 sec each)
	2 emergency doors for maintenance Full height x 800 mm width

### Waste Module Requirements

Waste module dimensions (LxHxD) (mm)	1350x1670x1150
	maximum allowable L is 1240 mm
Bins dimensions (LxHxD) (mm)	maximum allowable H is 1050 mm
	maximum allowable D is 780 mm
Weight (kg)	230 kg (Standard Waste)
Main features	The waste table can be symmetrically or asymmetrically located on the Waste Module (with possible extension on the left or right side)

#### Standard Waste

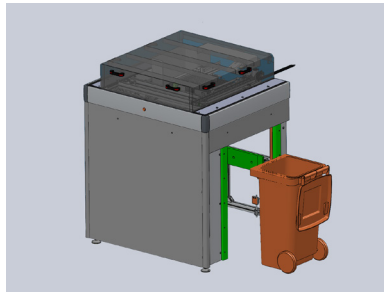

#### Waste with extension

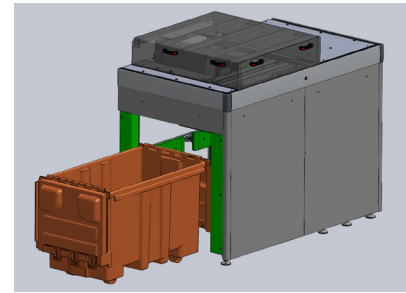

3D drawings

### Traslo Cage Tool Requirements\*

Dimension (LxHxD) (mm)	1380x2830x2280
Main clearances (left x right x front) (mm)	2000 mm in front of the door 1440 mm on the side of the cage where the electrical box is installed
Weight (kg)	250 (Traslo Backup) 112 (Traslo cart, including 30 kg for the lower moving part and 24 kg for the upper fixed part)
Compressed air (NL/min)	1.20
Power inlet point	230 Vac
Maximum continuous current (A)	/
Maximum alternate current (A)	3.3
Total power consumption (VA)	759.0
Heat (BTU/h)	2064.5
Positioning constraints	<ul style="list-style-type: none"> <li>· Located to the closer wall from the installed mHVS.</li> <li>· The ceiling height must be the same of the one of the mHVS</li> </ul>

3D drawings



Traslo Cage



Traslo Backup

Technical drawing

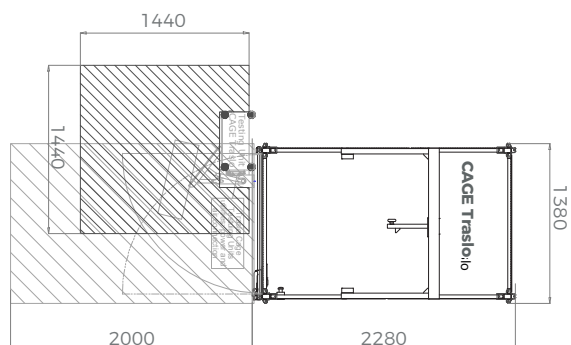

## IOM Tester Tool Requirements\*

Dimension (LxHxD) (mm)	1770x1725x2175
Main clearances (left x right x front) (mm)	600 mm on the electrical/pneumatic connection sides 1200 mm on the IOM input side 1000 mm on the front/rear operator sides
Weight (kg)	150 (IOM Tester Tool) 170 (IOM Backup)
Compressed air (NL/min)	12.34
Power inlet point	230 Vac
Maximum continuous current (A)	/
Maximum alternate current (A)	2.5
Total power consumption (VA)	575.0
Heat (BTU/h)	1564.0

3D drawings

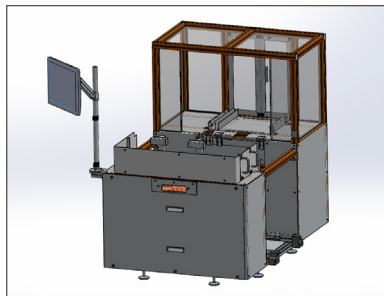

IOM Tester Tool

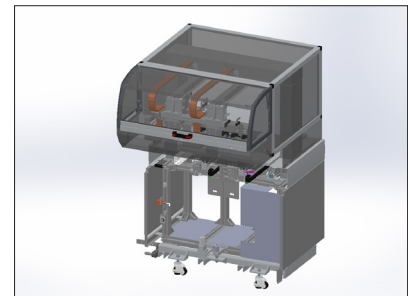

IOM Backup

Technical drawing

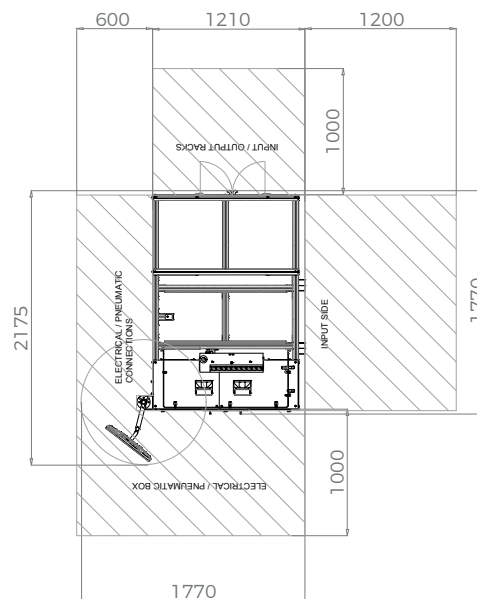

\* Notes:

- The specifications for the IOM Tester Tool and Traslo Cage are independent of the mHVS sizes.
- Traslo Cage and IOM Tools requires dedicated power supply and compressed air lines not shared with the ones of the main mHVS

## Space for Evaporators

There are three different position options, where the customer can locate the chosen evaporators inside the Refrigerated Room:

- Above Lateral Shelves**
- Above Central Shelves**
- Above Corridors**

### Above Lateral Shelves

Under this configuration:

- mHVS height includes evaporators height
- Evaporators height  $\leq 420$  mm
- Evaporators width  $\leq 400$ mm (right)
- Evaporators length  $\leq$  Refrigerator room length - 230mm

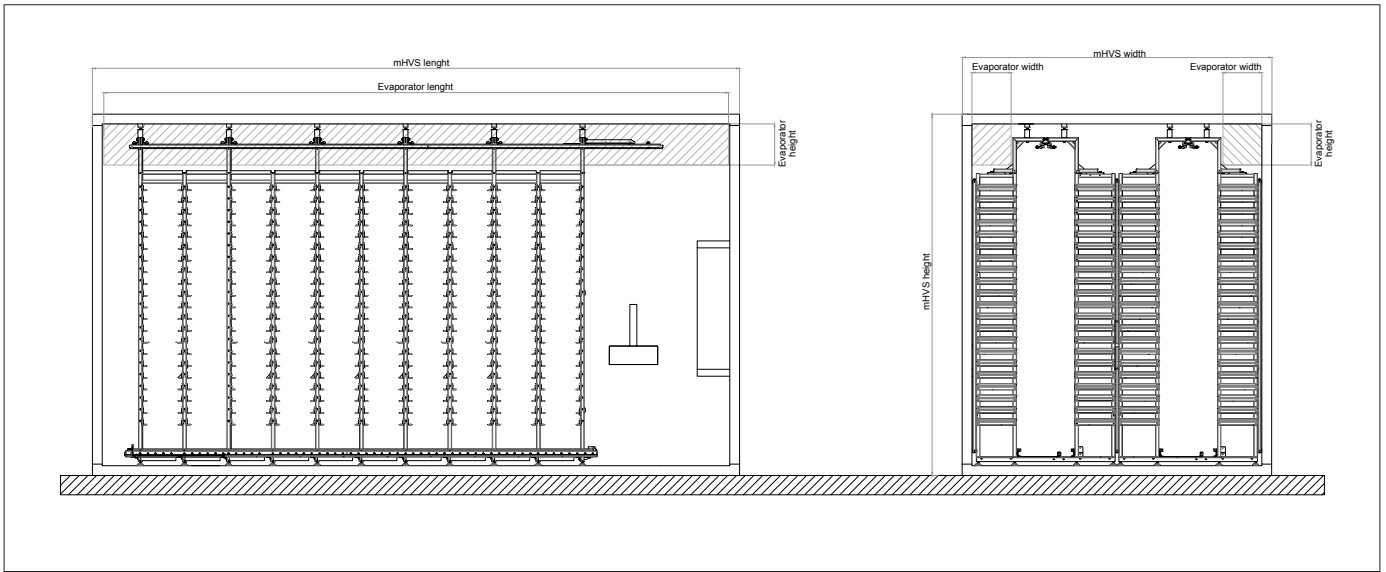

### Above Central Shelves

Under this configuration:

- mHVS height includes evaporators height
- Evaporators height  $\leq 420$  mm
- Evaporators width  $\leq 750$ mm
- Evaporators length  $\leq$  Refrigerator room length - 230mm - 1610mm, where 1610 mm is the wrequired space to allow the traslo movement inside the refrigerator cell

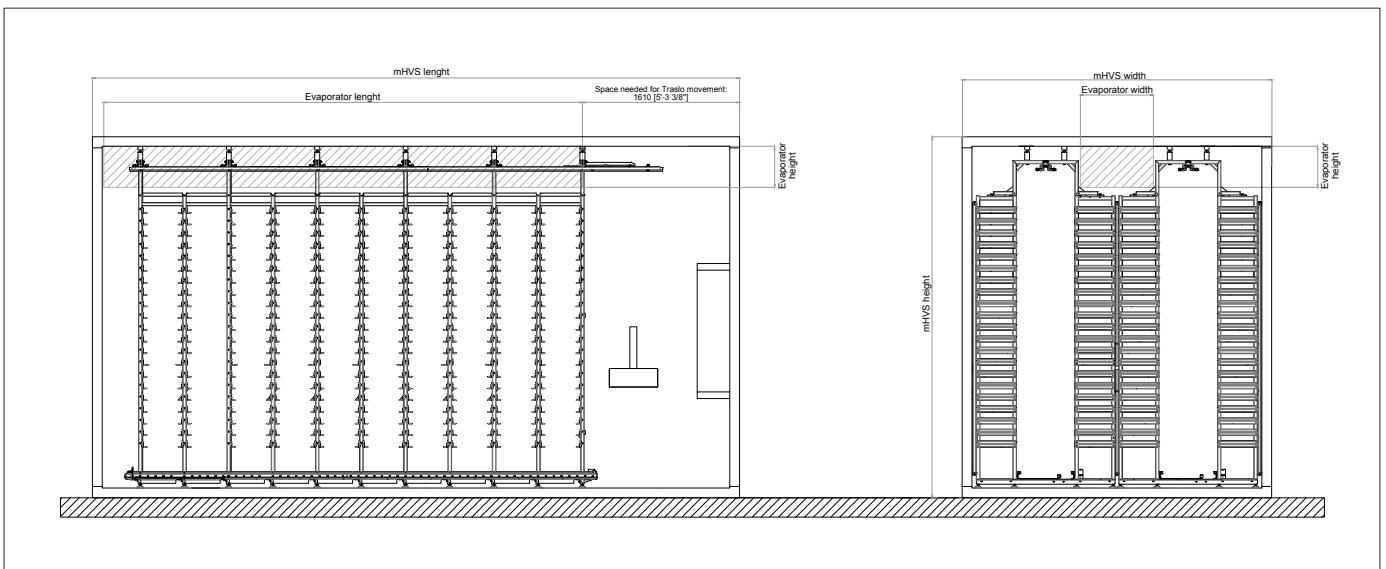

## Above Corridors

In case the chosen evaporators exceed the available dimensions of the "Above Shelves" configurations, they have to be placed on the mHVS corridors. With this configuration, an extension of the refrigerated cell is needed with an increment of the overall mHVS height. Consequently, the customer has to define the evaporator dimensions at the order definition in order to fix the overall mHVS height. Please, contact Inpeco to properly manage this solution.

Under this configuration:

- mHVS height must be incremented of evaporators height
- Evaporators width  $\leq 710\text{mm}$
- Evaporators length  $\leq$  Refrigerator room length - 230mm

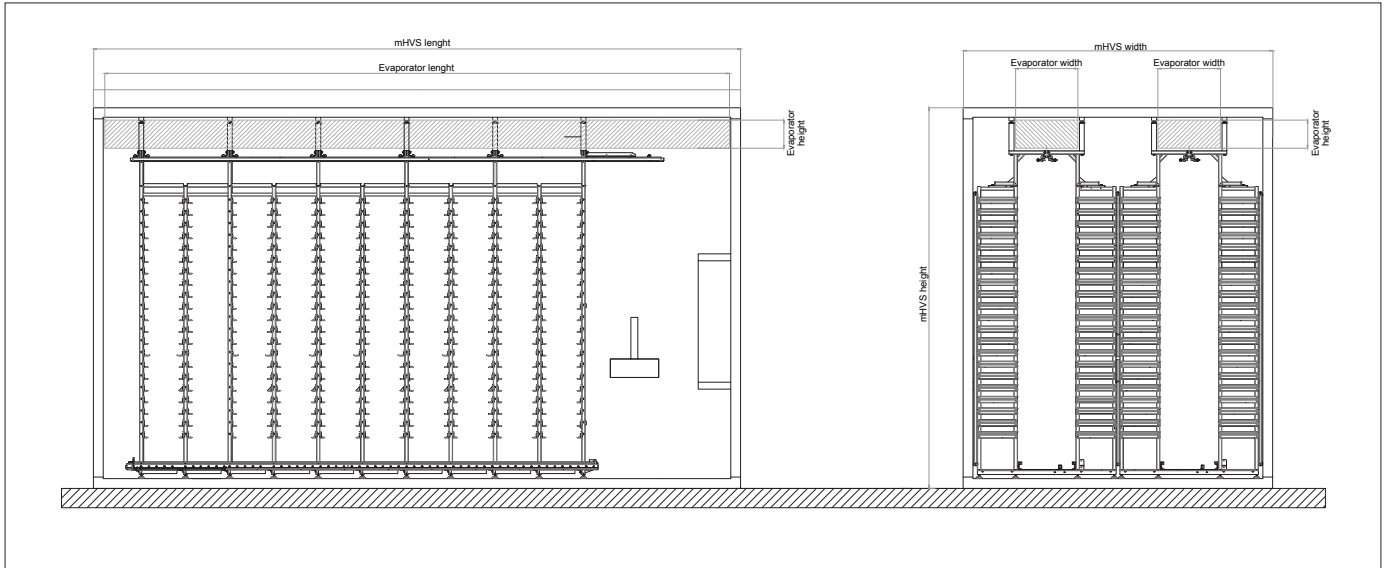

## Evaporators Fastening

There are two different solutions available to stably fasten the evaporators of the mHVS:

- **Fastening to the lab ceiling:** it consists on the fastening of the mHVS evaporators using cables passing through the mHVS Refrigerator Room and constrained into the lab ceiling above.
- **External Fastening to the mHVS ceiling:** it consists on a frame structure that uses longitudinal supports to hold the weight of the evaporators and to transfer their loading on the side walls of the mHVS.

Inpeco recommends for the evaporators installation the solution A because the mHVS side walls and roof are not structural nor certified to support any weight. In case of choosing the option B, the risk is accounted by the Customer. Inpeco is not responsible for solution design or installation of the Evaporators.

